

ARAYMOND, CLOSE TO YOU EVERYWHERE



www.araymond-industrial.com

YOUR CONTACTS INDUSTRIAL

Americas

USA, CANADA & MEXICO
contact.us@araymond-industrial.com

BRAZIL
contact.br@araymond-industrial.com

Asia

CHINA
contact.cn@araymond-industrial.com
+86 0511-85308727

INDIA
contact.in@araymond-industrial.com
+91 (2135) 676 200

JAPAN
contact.jp@araymond-industrial.com
+81 463 40 8600

SOUTH KOREA
contact.kr@araymond.com
+82 70 5055 5000

EMEA

BULGARIA, CZECH, HUNGARY,
POLAND, ROMANIA, SLOVAKIA,
SLOVENIA
contact.cz@araymond-industrial.com
+49 7621 174-222

FRANCE
contact.fr@araymond-industrial.com
+33 4 56 52 53 17

GERMANY
contact.de@araymond-industrial.com
+33 4 56 52 53 17

ITALY
contact.it@araymond-industrial.com
+34 935 216 933

SPAIN
contact.es@araymond-industrial.com
+34 935 216 934

TURKEY
contact.tr@araymond-industrial.com
+90 212 939 2627

UK
contact.uk@araymond-industrial.com
+44 1732 871934

ARaymond^{RG}

MORE THAN FASTENING

FASTENING AND ASSEMBLY SOLUTIONS FOR INDUSTRIAL MARKETS

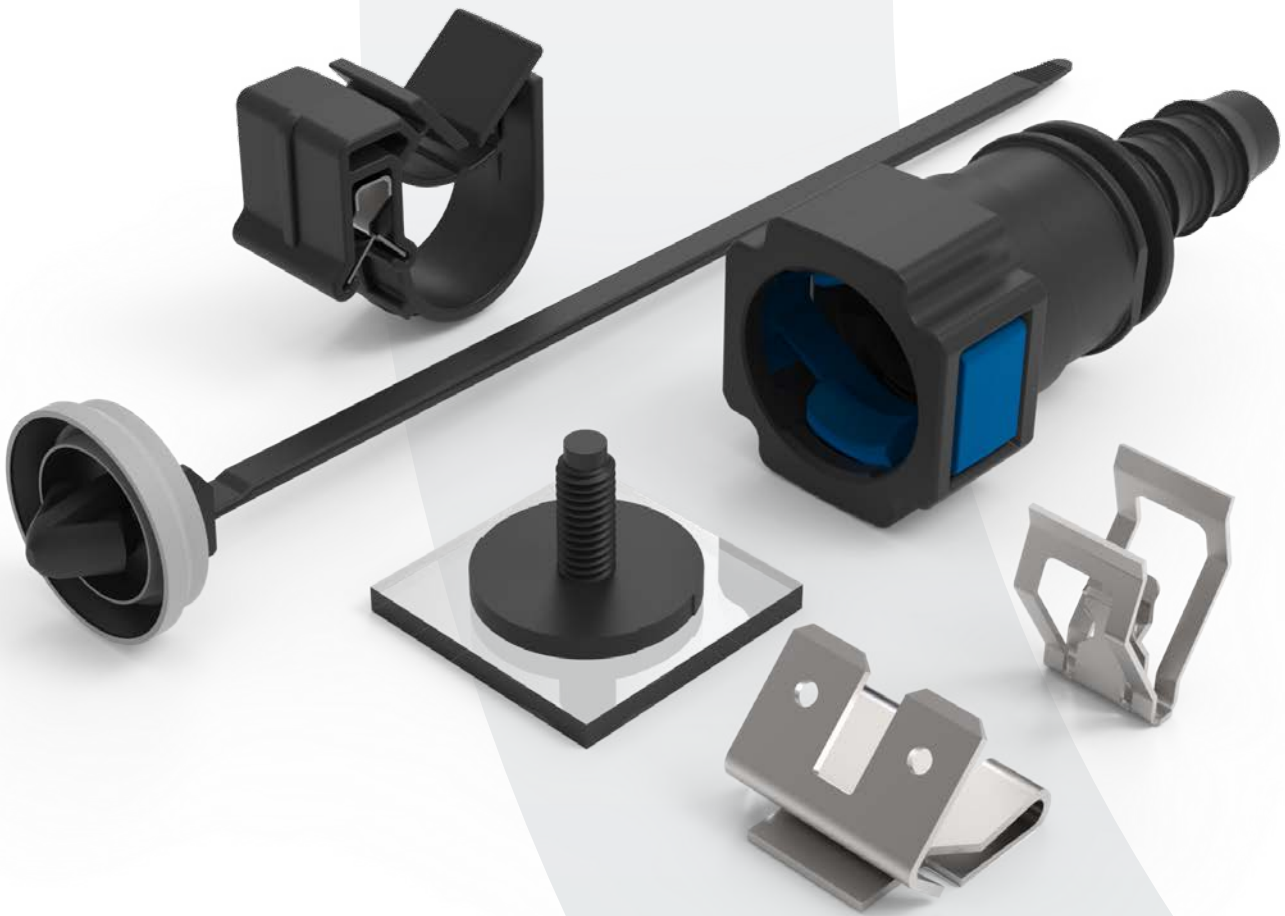

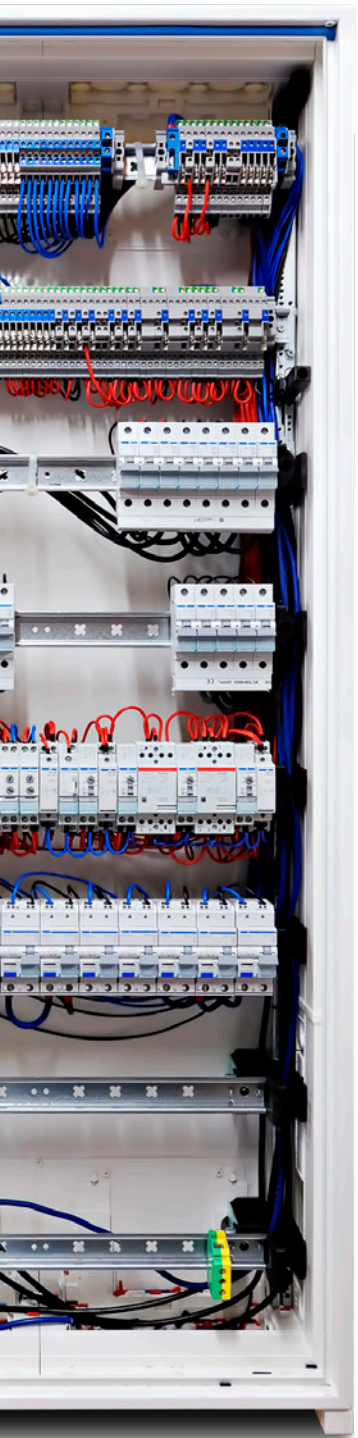



INTERNATIONAL EXPERT IN FASTENING AND ASSEMBLY SOLUTIONS

ARaymond Industrial is part of the ARaymond Network that has been an assembly expert since 1865. Throughout our long history, ARaymond has worked closely with its customers to simplify assembly processes and reduce the total cost of ownership.

With more than 155 years of experience designing, engineering and manufacturing assembly systems, ARaymond offers innovative solutions that eliminate the need for tools, improve assembly line ergonomics, streamline manufacturing, reduce total costs and facilitate serviceability.

From household appliances and electrical equipment to lighting and HVAC equipment, ARaymond can help make your assembly lines more efficient and add value to your products.

Presently in 25 countries, ARaymond's 7,270 employees are committed to delivering the clipping, fluid connection and lean bonding solutions you need, wherever and whenever you need them.



Improve ergonomics ++
Facilitate serviceability
Reduce total costs



A SOLUTION FOR ANY ASSEMBLY SITUATION

CLIPPING SYSTEMS

ARaymond Industrial offers a wide range of standard and tailor-made fasteners that **ensure quick, easy, no-tool assembly** for **more efficiency** and a **qualitative assembly process**.

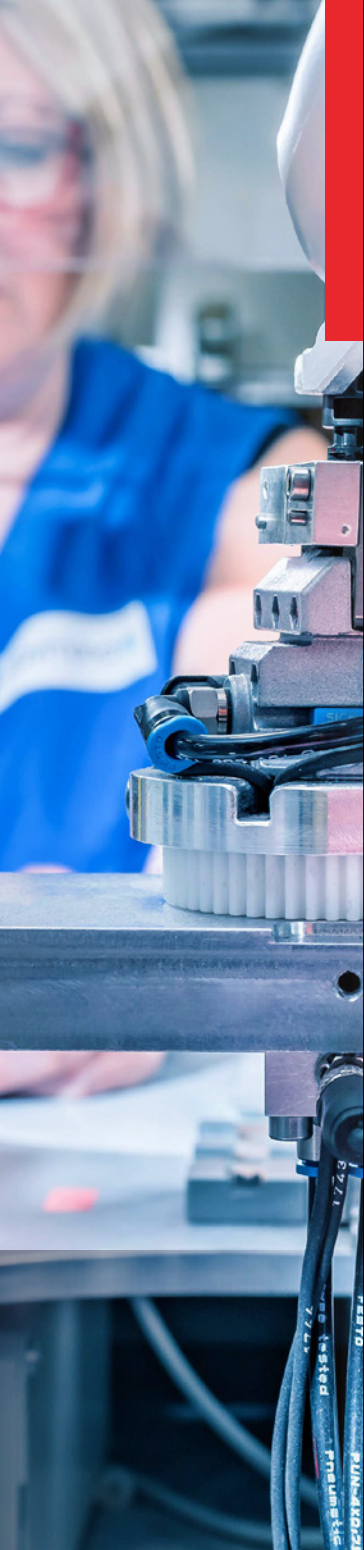

CLIPPING SYSTEMS P.6

- CABLE & TUBE FASTENERS P.6
- PANEL & TRIM FASTENERS P.8
- THREADED FASTENERS P.10
- PUSH-ON STUD RETAINERS P.13

PROTECTING & FINISHING P.14

METAL ANTI-CREEPING RINGS / GROMMETS / PLUGS

GROUNDING CLIPS P.15

WITH SHEATHING / LUGGED, WIRIS® GROUNDING CLIPS

QUICK CONNECTORS FOR FLUID LINES P.16

- QUICK CONNECTORS INTRODUCTION P.16
- SELFY, P2L® AND VALUE ADDED FEATURES P.17
- QCS FOR MANUFACTURERS HEATING AND AIR CONDITIONING P.18
- QUICK CONNECTORS FOR PLUMBING FIXTURES P.18

BONDING SOLUTIONS FOR INDUSTRIAL APPLICATIONS P.20

- BONDING FOR AN OPTIMUM FINISH P.20
- BONDING TO AVOID DRILLING OR WELDING P.21
- BONDING OF FASTENERS FOR BETTER SERVICEABILITY P.21

VALUE-ADDED ASSEMBLIES P.22

BRACKETS / ELECTRICAL ROUTING & HIGH-VOLTAGE SOLUTIONS

PRODUCT DEVELOPMENT P.23

MANUFACTURING EXPERTISE P.23

ARAYMOND INDUSTRIAL CONTACTS P.24

QUICK CONNECTORS FOR FLUID LINES

ARaymond™ Quick Connectors for fluid lines provide **fast, easy, safe, and reliable connections** for all types of fluid systems.

BONDING SOLUTIONS FOR INDUSTRIAL APPLICATIONS

ARaymond™ bonding solutions are **tailor made complete systems** including adhesive, process and services that ensure production and quality achievements.

CLIPPING SYSTEMS



CABLE & TUBE FASTENERS

Supporting your standardization strategy our solutions manage easily **all tubes and cables** such as continuous tubes, bundles of tubes or cables, corrugated hoses, and more. They are compatible with all common **mounting strategies**: round, oval, oblong, and square holes, blind holes, studs and edges. They are available in **several designs** for a wide range of diameters, and panel thicknesses and can manage multi-housings.



MARKETS

White goods, HVAC, electrical cabinets, industrial machinery, household consumer items, commercial & industrial furniture, specialty vehicles.

REFERENCED APPLICATIONS / USES

Wire harness & cable management.

PRODUCT BENEFITS

Weight savings, watertight, modularity, ergonomics, temperature resistant, vibration and noise reduction.

CABLE STRAPS

- Wire harness diameters from 0.5 to +40 mm
- Multiple mounting options available (hole, stud, tube, panel edge)
- Broad range of options: removable tie straps, various strengths, materials and colors



ONE PIECE SOLUTION FOR WIRES AND PIPES

Single molded swivel clip

- Locking 90° - swivels 90°
- Bundle diameter from 1 to 40 mm



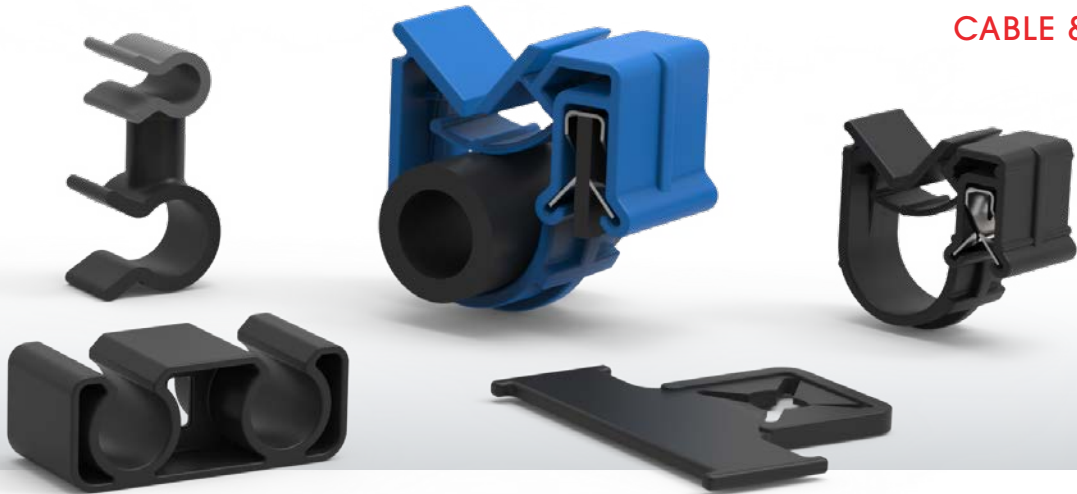

TUBE HOLDERS & CABLE CLIPS

- Available in all common smooth and corrugated tube diameters
- Available in plastic, stainless or spring steel, or a combination of both
- Multiple mounting options available (hole, stud, tube panel edge)
- Broad range of product enhancements: live hinges, locking and adjustable

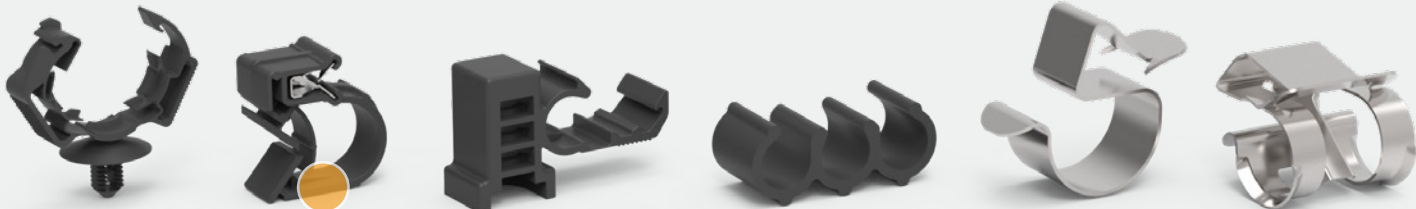

Plastic cable clip can be combined with spring steel insert to improve retention

STANDARDIZATION OF PARTS

- Reduced number of required parts from six to two (based on real TCO cases)
- Tool-free design
- Provides quick assembly and a reliable connection, increasing assembly line efficiency

Bi-injected materials absorb vibrations and reduce noise

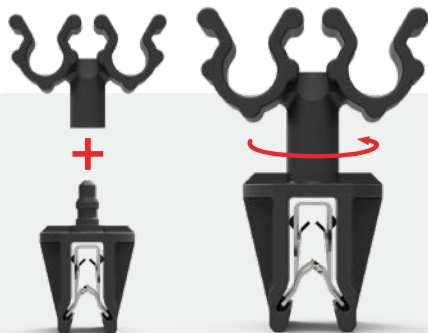
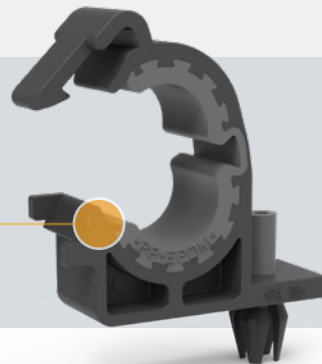

MODULAR SOLUTIONS

- Pre-assembled swivel clips offer mix and max options to create your ideal solution
- Wide variety of diameters and design configurations
- Combine male and female parts to create your unique fastener
- Can be delivered pre-assembled or manually assembled at your plant

ADAPTORS

- Effectively manage wiring in a wide range of manufactured products and equipment
- Includes plastic, metal, and plastic/metal assemblies

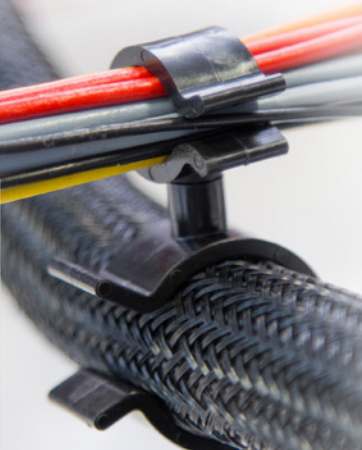
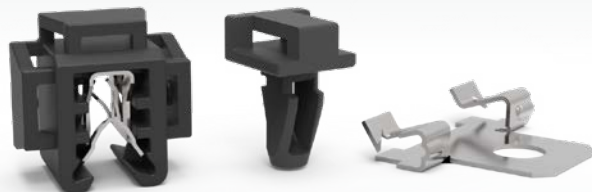

CLIPPING SYSTEMS



PANEL & TRIM FASTENERS

All-in-one panel fasteners are **fast and easy** to assemble and disassemble easily and reliably. Choose from metal parts to **reduce vibration** or plastic for **cost-effectiveness** and **corrosion-resistance**. Our screwless fasteners can accommodate **most panel sizes and configurations** and our snap-fit panel fasteners are hidden and provide for an unblemished exposed panel surface.



MARKETS

White goods, HVAC, electrical cabinets / lighting, lawn and garden equipment.

REFERENCED APPLICATIONS / USES

Panel assembly, hidden fasteners.

PRODUCT BENEFITS

Preserved aesthetics, serviceability, compact packaging, watertightness, vibration and noise reduction.

EDGE PANEL CLIPS

- Multi-functional: metal to metal or metal to plastic
- Fast and easy manual mounting – requires no screws, welds, rivets, or other secondary fastening devices
- Designed for parallel, non-parallel and perpendicular panel orientations

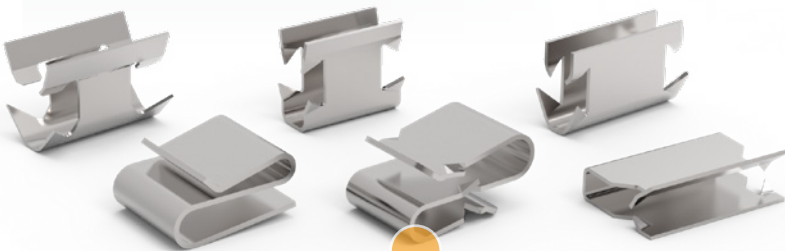

Integrated barbs provide a tight grip and secure assembly

ASSEMBLY AND MOUNTING OF LIGHTING FIXTURES

- Optimized for small environments
- Fast, manual assembly attaching grill to luminaire
- Provides an aesthetic finish

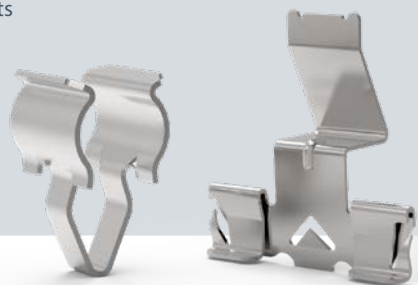

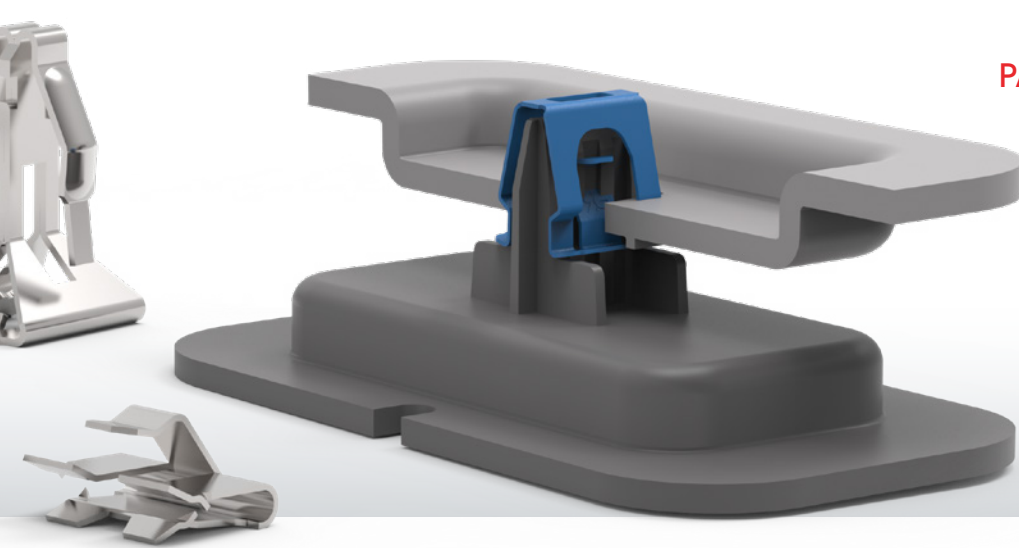

SNAP CLIPS

- No tools or screws required, providing a quick, easy assembly
- Ergonomic push-in force
- Easily serviceable
- Hidden once mounted
- High-strength versions available

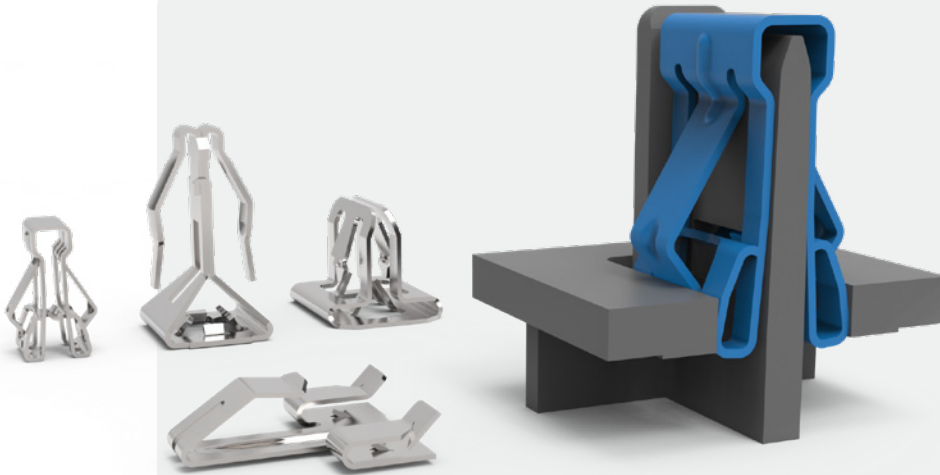

SPEED UP CONTROL PANEL ASSEMBLY

- Reduced 6 screws to just 2 snap clips
- Shorter assembly time
- Operators work became more ergonomically friendly
- Manual installation was facilitated by a tool-free design
- Hidden fastening solution provides an aesthetic finish with no "sink" marks



DART CLIPS, PUSH-PINS & RIVETS

- Ergonomic push-in force
- Easily serviceable
- No need for tools or screws
- Can be grained or color matched for Class A surface



CLIPPING SYSTEMS

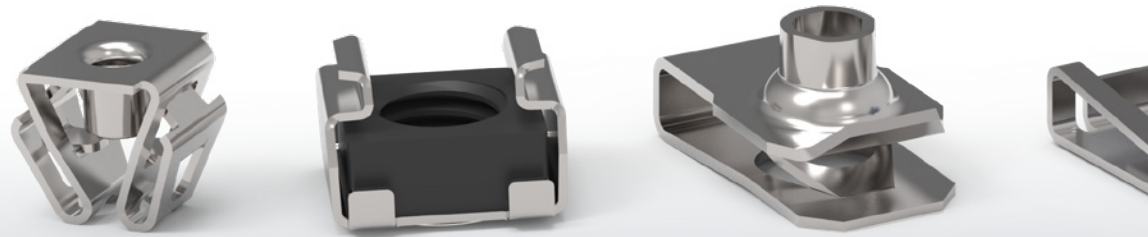

THREADED FASTENERS

ARaymond threaded fasteners are as dependable as traditional threaded fasteners with the added versatility of spring steel. Our standard parts include **solutions** for most **panel sizes, orientations** and **thicknesses**, as well as **solutions** for **metric, self-tapping** and **PT thread screws**.



MARKETS

Used in most assembly environments/ applications where two panels need to be attached.

REFERENCED APPLICATIONS / USES

Panel assembly.

PRODUCT BENEFITS

Anti-creep, tolerance management, vibration absorption, water tightness, robust.

PANEL EDGE NUTS



VIBRATION CONTROL

- Prevailing torque option prevents loosening in applications that undergo excessive vibration, like lawnmowers and snowblowers
- Parts self-retain in screw-receiving position for faster assembly
- Eliminate the need for costly welding and clinching
- Ideal for assembling lawnmower chassis and shields

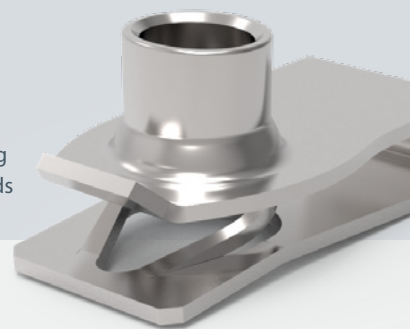

- Used to provide simple, rapid attachment of mating panels
- Self-retention feature improves assembly time and eliminates costly welding and clinching
- Single-impresion or tapped barrel with prevailing torque available
- Serviceable - parts disassemble easily and reliably
- Integrated guide flaps allow automated assembly process
- Metric and imperial

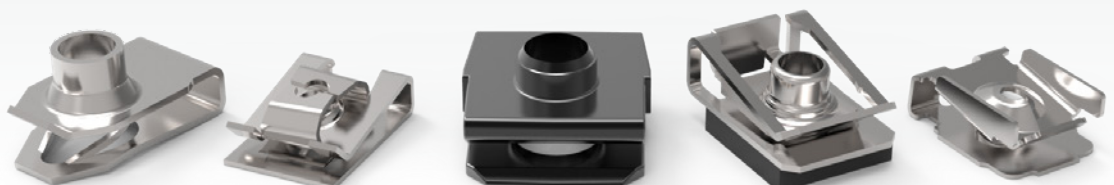

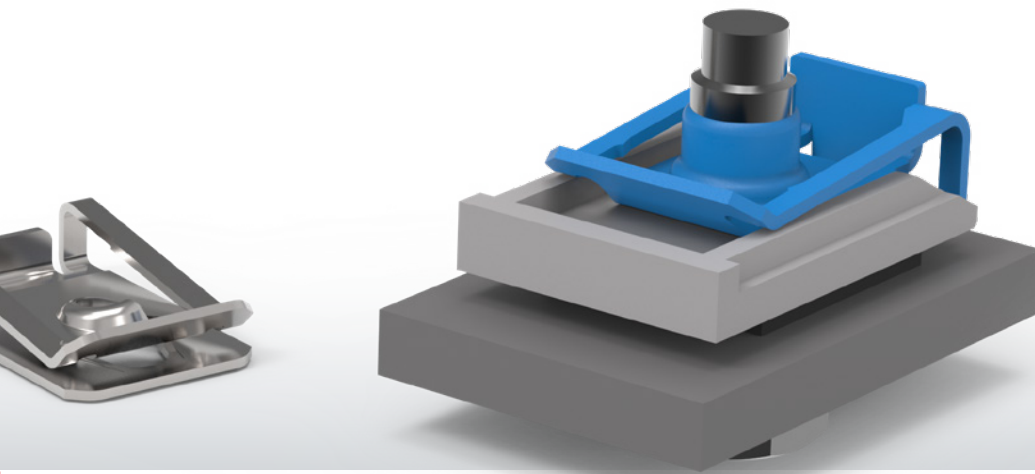

EXPANSION NUTS & PLASTIC PUSH-INS

- Fast, vibration-resistant assembly for blind and center-panel locations where only one side is accessible
- Easy to snap in, retained by spring legs
- Available in box or robotics style designs
- Plastic for applications where metal to metal contact is not desired



CAGE NUTS «MID-PANEL»

- Attach components to panels with square holes
- Snap readily into bolt receiving position at center panel locations
- Self-retain
- Can be applied at any convenient spot along the assembly line
- Account for normal build variation
- Ideal for blind location assembly

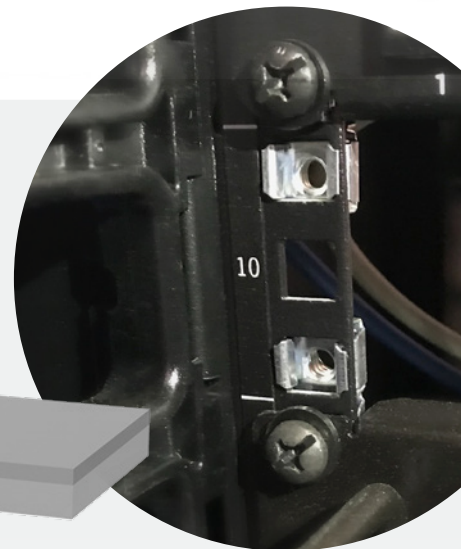
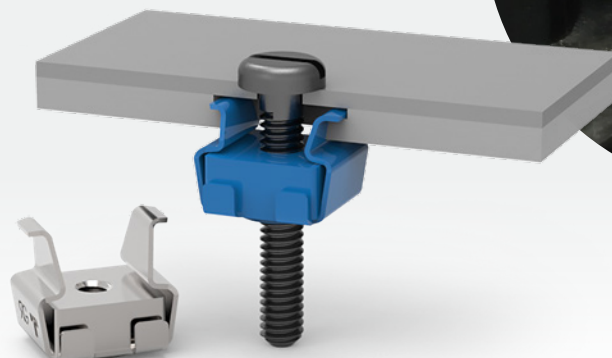



THREADED RETAINERS

ARaymond's threaded retainers are **easily assembled** and provide **maximum retention** at a **low cost-per-fastener**. They cannot be loosened by vibration but can be easily loosened when needed. And, because they eliminate the problem of rust-frozen screw threads, these fasteners are ideal for HVAC, white goods and other similar equipment.



MARKETS

HVAC, white goods.

REFERENCED APPLICATIONS / USES

Panel assembly.

PRODUCT BENEFITS

Vibration resistant, serviceability, high-retention.



THREADED RETAINERS

- Threaded or smooth studs
- Available in hex or washer designs
- Used in place of traditional hex nuts for reduced weight or applications requiring lower torques
- Compact design

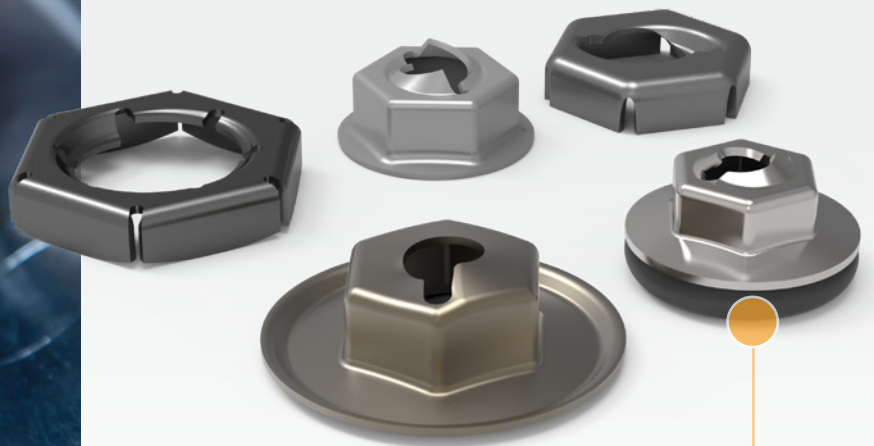

Addition of a seal prevents noise and water intrusion

PUSH-ON STUD RETAINERS

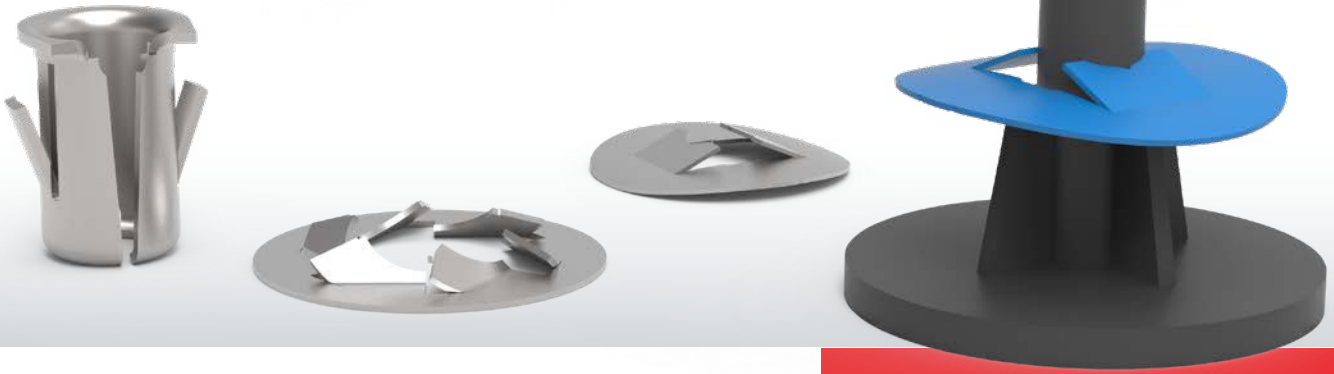

PUSH-ON STUD RETAINERS

ARaymond's push-on stud retainers are an **easy way to hold screws or bolts** in place before the nut is positioned and tightened. They are easy to assemble, accommodate most panel orientations and sizes and are very compact for when space is limited.

Parts are available in smooth studs, metric studs, weld-studs, and grooved studs or shafts



MARKETS

Industrial machinery, household consumer items.

REFERENCED APPLICATIONS / USES

Panel assembly.

PRODUCT BENEFITS

Preserved aesthetics, serviceability, compact packaging, vibration and noise resistance.

PUSH-ON STUD RETAINERS

- Threaded or smooth studs
- Used to prevent two panels from disengaging
- Compact design allows parts to be used in areas where space is limited
- No special tools required, eliminating time-consuming assembly operations



THE PERFECT FINISH FOR PRODUCTS WITH VISIBLE STUD ENDS

Decorative push-on fasteners

- Hide unattractive shaft, stud or rod ends
- Combine the reliability of spring steel with a colorful, plastic cap or shiny decorative top hat
- Provide dependable, vibration-resistant assemblies
- Ideal for a wide range of products including toys, garbage cans and coolers

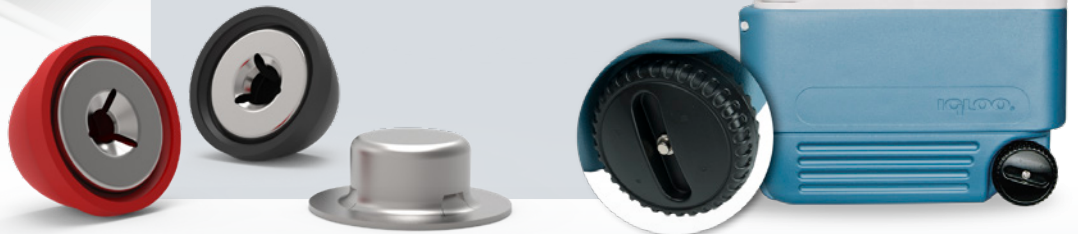
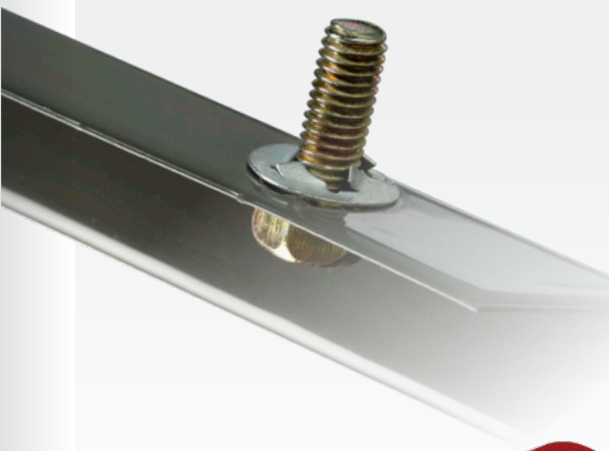

PROTECTING & FINISHING

Our protecting and finishing fasteners are ideal to protect your products from dust and water infiltration and keep plastic from creeping, **our wide range of protecting and finishing fasteners is ideal.**



MARKETS

White goods, heavy duty machinery, electrical, lighting.

REFERENCED APPLICATIONS / USES

To seal holes, avoid water intrusion and dust ingress, to prevent wires/tubes from being damaged, improve product aesthetics.

PRODUCT BENEFITS

Quick and easy assembly, improve aesthetics, helps maintenance.

METAL ANTI-CREEPING RINGS

Transmit the locking torque of the screw while preventing plastic creeping, thus stabilizing the screwing points.



GROMMETS

- Keep wires and tubes passing through panel holes from being damaged
- High quality sealing
- Reducing vibration and associated noise



PLUGS

- Tight seal against water and dust
- Water evacuation feature available
- Easy serviceability

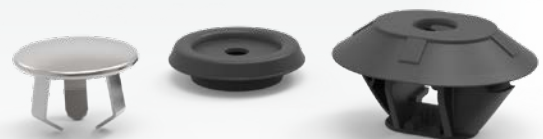

GROUNDING CLIPS



Ensure electrical conductivity between metal panels and electrical wiring in just one step

- Lightweight
- Tool-free for easy assembly
- High pull-off resistance
- Ergonomic assembly



MARKETS

White goods, HVAC, electrical, lighting.

REFERENCED APPLICATIONS / USES

Allows the connection of metallic elements to the ground without the requirement of holes, welded studs, toothed and threaded washers.

PRODUCT BENEFITS

Saves time on the production line, reduces number of parts, improves ergonomics, less tools required.

GROUNDING CLIPS WITH SHEATHING

- Ensure conductivity between a panel edge and a H07V-K6-type grounding wire
- Ideal for use in electrical cabinets
- Connection in just one movement

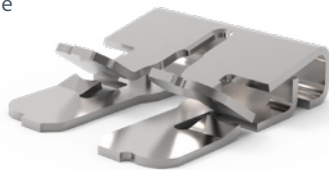

LUGGED GROUNDING CLIPS

- Ensure conductivity between a metal edge panel or a stud and a grounding wire with a lug connector
- Reliable connection even when metal panels are painted or given other surface treatments
- High pull-off resistance



WIRIS® GROUNDING CLIPS

- Reducing assembly operation
- Reducing semi-finishing operations
- Reducing number of parts
- Standardization

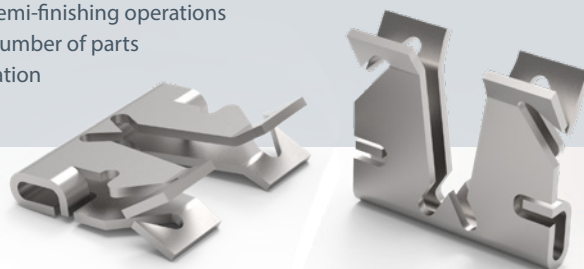

QUICK CONNECTORS



ARaymond™ Quick Connectors for **fluid lines** are ideal for HVAC and domestic water equipment. Our quick connectors can reduce the use of copper and eliminate the need for brazing, self-gripping and screwing tasks on the assembly line. These modular solutions are also **easy to handle** and provide a **secure connection**.



Secure connection

Easy to handle

Tight seal

Time, space and weight savings



Selfie – audible, tactile and visual connection confirmation in one assembly operation

Adapt to any packaging environment with a wide range of geometries, angles and multiways.



P2L® manual connection with visual confirmation

SELFY QUICK CONNECTOR

Simple, smart, secure

In response to a customer request for a specific feature, ARaymond developed a Quick Connector with automatic double locking. The Selfy Quick Connector exceeded the customer's expectations, securing connection operations on the production line.

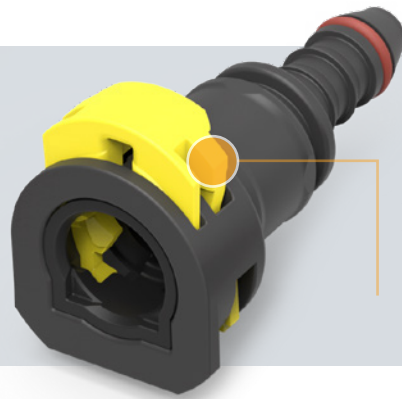

Foolproof connection with audible, tactile, and visual confirmation in one assembly operation 100% automatic.

P2L®: MANUAL CONNECTION WITH VISUAL CONFIRMATION

For transmission and engine oil cooling lines requiring higher operating pressure, a metal insert can be added to allow better tube crimping and higher pull-out force.



A FUEL CONNECTOR FOR DEMANDING CONDITIONS

Metal P2L®

- Improved temperature, and pressure performance
- Crimping to reinforce high-temperature fuel hoses in the engine compartment



VALUE ADDED FEATURES

MECHATRONICS: FLUID PRESSURE & TEMPERATURE MEASUREMENT

- Smart and compact
- 2 in 1 solution: fluid connection & pressure or temperature measurement
- Easy change of measuring range by changing the sensor without additional hardware needed



VALVES: FLUID FLOW CONTROL

- One-way valve
- Calibrated valve
- Pressure regulator
- RG® Valve: allows priming with the system for when access is required for maintenance or troubleshooting



QUICK CONNECTORS FOR MANUFACTURERS HEATING AND AIR CONDITIONING



FEMALE-FEMALE QC: A FAST, SIMPLE ASSEMBLY SOLUTION TO REPLACE BRAZING

Heat pump manufacturers commonly use brazing to join two metal parts. Our Quick Connectors provide a **heat- and fire-free alternative**. They **simply click into place, for a fast, safe connection**. The 100% plastic solution is also compatible for use with flammable fluids.

A secure, robust connection for heat pumps

- 100% leak tested in our factory, guaranteeing a **safe connection**
- Helium leak tests are performed to prevent refrigerant fluid leaks that could **limit the lifetime and performance** of the system and harm the environment
- **Secure and robust connection** for heat pumps, which are designed to withstand pressure of up to 30 bars for Ø7.89 and Ø9.49 and burst pressure of 100 bars
- Quick Connectors are compatible with current and future refrigerant fluids
- We have obtained the relevant industry certifications (ISO 14903, for example) for our products



QUICK CONNECTORS FOR PLUMBING

ARaymond™ solutions for fluid delivery systems are valued for their comprehensive range and adaptability. They are suitable for most configurations due to a **large variety of angles, geometries, diameters**, levels of temperature or pressure and kind of fluids (water, air, refrigerants, oils...).

ARaymond™ Quick Connectors ensure a **safe connection and integrate functions** like valves and temperature or pressure sensors to add value to your products



A MODULAR, SECURE CONNECTION

We provide **Quick Connectors for small and modular air conditioning units** (residential and small commercial) and for heating equipment like heat pumps. Heating and air conditioning equipment manufacturers operate in a changing regulatory landscape, which affects design and assembly processes (currently dominated by brazing). **ARaymond offers solutions** to ensure that air conditioning manufacturers stay in compliance with regulations.

FLEXIBLE, REMOVABLE SOLUTIONS FOR AIR CONDITIONING LINES

We offer Quick Connectors designed specifically for air conditioning manufacturers. Our flexible solutions are easy to dismantle, saving time on the production line and during maintenance. Our Quick Connectors provide a clear confirmation that the connection is secure, and are 100% leak-proof for the lifetime of the equipment (fifteen years). Our Quick Connectors can withstand service pressure of up to 30 bars and temperatures from -30°C to 130°C.

EASIER MAINTENANCE

Quick Connectors facilitate the maintenance of equipment, they can be dismantled in one click and can be assembled and reassembled several times. Pressure, temperature, and flow sensors can be integrated directly into the Quick Connectors, adding value to your products.



FIXTURES

QUICK CONNECTORS FOR PLUMBING FIXTURES AND FITTINGS

With ARaymond value-added solutions you can assemble your water pipes together with one click, avoiding screwing processes in order to **optimize and facilitate your assembly operation**.



- Compatible with drinking water and factory tested to resist leaks
- According to our in-house water hammer resistance testing for water distribution equipment, our products can withstand pressure of up to 50 bars at 90 ±C
- Product range covers many diameters and includes optional integrated pressure, temperature, and flow sensors
- Also include one-way valves and removable connectors

BONDING SOLUTIONS



ADHESIVE BONDING

Adhesive bonding is a very efficient assembly solution, although it might sometimes be seen as stressful, costly and time consuming.

ARaymond believes in **bringing peace of mind** to its customers by building complete bonding solutions based on their needs and in close collaboration with them.



Customized and complete bonding solution

High performance assembly

Quick curing adhesives

We make a focus on high performance assembly with quick curing adhesives and use a **dedicated project methodology** to commit to the success of all your bonding operations.

- We design a customized and complete bonding solution
- We implement and integrate the process and equipment
- We ensure serial life support

These complete bonding solutions allow our customers **to bond every time in optimum conditions and reach their performance and quality expectations.**

BONDING FOR AN OPTIMUM FINISH

As aesthetics are increasingly important in product design, manufacturers are seeking new solutions offering invisible assembly. ARaymond, with its bonding solutions, provides panels assemblies with a perfect flush finish with no holes nor weld marks.

SECURED AND AESTHETICALLY-PLEASING RESULTS

Our high-performance bonding solutions are a smart alternative to mechanical fastening whenever welding and drilling are not possible or when a perfect finish is required.

We developed a bonding solution for one of our customers that consisted of studs bonded to the back of a radiator's decorative front panel.

The **process was fully automated for flexibility and throughput**, and the result was both secured and aesthetically-pleasing.

Studs bonded to the back of a radiator's decorative front panel.

BONDING TO **AVOID DRILLING OR WELDING**

When it comes to glass or thin metal surfaces, manufacturers are constantly on the lookout for **innovative ways to achieve efficient fastening**.

As an example, mounting hinges on glass panels is a challenge that can be overcome by bonding. ARaymond high-performance bonding solutions insure a **robust assembly** that stands the test of time.

Our bonding solutions' resistance to aging has been proven again and again in the automotive industry, where they have been used to assemble ball joints for years.

We can develop a bonding solution that responds to your **unique needs and situation**. Our tailor made solution includes the product, process, and associated services and support throughout the solution's lifespan on your production line.



BONDING OF FASTENERS FOR **BETTER SERVICEABILITY**

When it comes to **serviceability**, panels with bonded fasteners can be easily disassembled. Moreover, reactive adhesives can reach **high level of performance** for thin metal and glass panels assemblies.

As an assembly expert, ARaymond can provide you the most appropriate fastener with the optimum bonding solution to answer your assembly and serviceability needs.



VALUE-ADDED ASSEMBLIES

ARaymond offers application specific development services to respond to OEM's and part manufacturers' assembly challenges. We handle all stages of manufacturing in-house, from design and prototyping, to tool creation, all the way through metal transformation, plastic injection molding and assembly of detailed parts.

BRACKETS

ARaymond offers mechanical bracket supports in metal, plastic or a combination of the two. Products can suit almost any packaging requirement.

SPRING STEEL

Metal brackets for robust, temperature-resistant assembly



PLASTIC

Lightweight and cost-effective. Can be reinforced with metal and anti-creep inserts



PLASTIC & METAL ASSEMBLY

Vibration reduced through product design or by applying plastic materials

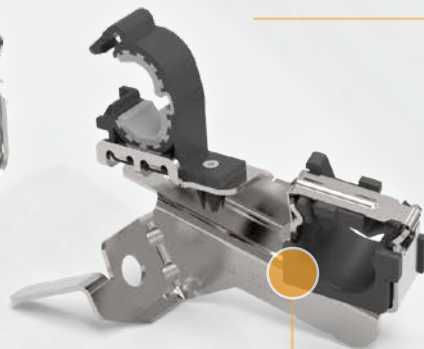

ELECTRICAL ROUTING & HIGH-VOLTAGE SOLUTIONS

Cable Channels

Our many years experience and design expertise allow us to develop cable channels which are optimized to fit both our wire harness customers and OEMs requirements and specifications.

Made out of injection-molded plastic, with or without metal inserts with optimized number of attachment points, quick and easy mounting as well as repeatable assembly.

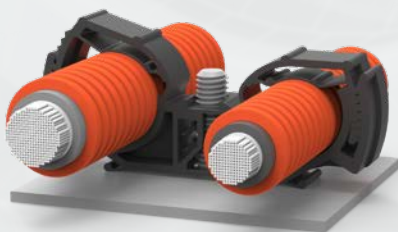

Robust Clips

For use with high-voltage cables, these clips are fully serviceable due to the robust cable latch feature. Also includes an anti-vibration feature.

PRODUCT DEVELOPMENT

ARaymond's Advanced Engineering team develops products for industrial customers with the key objectives of **simplifying assembly and reducing total cost**. Our engineers use practices like line walks and tear-downs to pinpoint potential improvements and recommend innovative, market-driven solutions.



ARaymond has eleven engineering centers worldwide, offers full-service prototyping and product design validation, and **reinvests 6% of its annual revenue in R&D** each year.

MANUFACTURING EXPERTISE

Our state-of-the-art highly-automated facilities, are equipped with robots and video quality systems. We also have cleanrooms for pharmaceutical packaging parts, and grey rooms for the manufacture of fluid line connectors. All of our automotive-parts plants are IATF 16949 certified and we have obtained ISO 14001 certification for all of our manufacturing facilities worldwide.

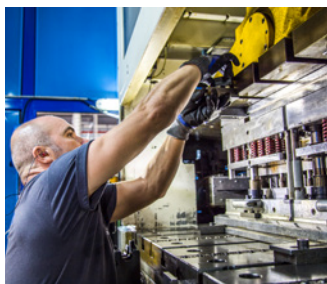

Metal transformation



Platic injection



Assembly

METAL TRANSFORMATION

At ARaymond, we manage all major metal transformation processes – cutting, bending and stamping. We work with spring steel, stainless steel, brass and copper and can provide single or multi-layer surface treatments.

PLASTIC INJECTION

ARaymond facilities are equipped with late model, standard and bi-injection molding machines with the capacity to run less than 10 second cycle times and manage 128-cavity molds.

ASSEMBLY

ARaymond's plants, worldwide, handle all modes of assembly: manual, semi-automated, and cycle-time optimized fully-automated assembly.

ADHESIVE TECHNOLOGY

ARaymond's adhesive technology offers a complete solution to the challenges of structural adhesion. Our bonding solutions are custom-developed to meet your unique needs and backed by the personalized support of a Bonding Solutions Architect to ensure maximum performance and satisfaction throughout its lifetime.



Adhesive Technology