

PowAR® Cinch Locked

V.1 (2023/09)



- EN INSTRUCTIONS MANUAL
- ES MANUAL DE INSTRUCCIONES
- FR MANUEL D'INSTRUCTIONS
- PT MANUAL DE INSTRUÇÕES
- TR KULLANIM KILAVUZU
- ZH 使用说明书
- JA 取扱説明書

EN **Storage conditions:**

- Prior to installation, all Products must be kept in their original packaging, including bags, boxes, protective film and pallets and thus without any damage.
- No pallet stacking is allowed to avoid boxes damages.
- All pallets or other packaging should be stored on a flat surface to avoid collapsing.
- All products must be stored in a dry, well-ventilated covered environment, to ensure that the Products are protected from environmental conditions (rain, snow, or humidity ...) to prevent collapse and moisture ingress.

ES **Condiciones de almacenamiento:**

- Antes de la instalación, todos los productos deben mantenerse en su embalaje original, incluyendo bolsas, cajas, película protectora y paletas, y, por tanto, sin daños.
- No se permite apilar las paletas para evitar daños en las cajas.
- Todas las paletas u otros embalajes deben almacenarse en una superficie plana para evitar que se caigan.
- Todos los productos deben almacenarse en un entorno seco, bien ventilado y cubierto, a fin de garantizar que estén protegidos de las condiciones ambientales (lluvia, nieve, humedad...) para evitar que se caigan y les entre humedad.

FR **Conditions de stockage :**

- Avant l'installation, tous les Produits doivent être conservés dans leur emballage d'origine, non altéré, y compris les sacs, les cartons, le film de protection et les palettes.
- Il n'est pas permis de gerber les palettes afin d'éviter d'endommager les cartons.
- Toutes les palettes ou autres emballages doivent être stockés sur une surface plane afin d'éviter les affaissements.
- Tous les produits doivent être stockés sous un abri sec et bien ventilé, afin d'assurer que les Produits sont protégés des intempéries (pluie, neige, humidité...) pour prévenir l'affaissement des cartons et l'exposition à l'humidité.

PT **Condições de armazenamento:**

- Antes da instalação, todos os Produtos devem ser mantidos na sua embalagem original, inclusive sacos, caixas, filme protetivo e pallets e, portanto, sem apresentar qualquer dano.
- Não é permitido empilhar pallets para evitar danificar as caixas.
- Todos os pallets e outras embalagens devem ser armazenados em uma superfície plana para evitar quedas e colapsos.
- Todos os produtos devem ser armazenados em um ambiente seco, coberto e com boa ventilação, para garantir que os Produtos sejam protegidos de intempéries (chuva, neve e/ou umidade, etc.) e para evitar colapsos e o ingresso de umidade.

TR Depolama koşulları:

- Kurulumdan önce tüm Ürünler, torbalar, kutular, koruyucu film ve paletler dahil kendi orijinal ambalajlarında, hiçbir hasar almayacak şekilde saklanmalıdır.
- Kutuların zarar görmelerini önlemek için paletlerin istiflenmesine izin verilmez.
- Ezilmeleri önlemek için tüm paletler ile diğer ambalajlar düz bir zeminde depolanmalıdır.
- Ürünlerin çevre şartlarından (yağmur, kar veya nem, vb.) korunmalarını sağlamak, ezilmelerini ve nem girişini önlemek için tüm ürünler kuru, iyi havalandırılan kapalı ortamda saklanmalıdır.

ZH 存储条件:

- 安装前, 所有产品必须保持原包装状态, 包括包装袋、包装箱、保护膜和托盘, 不得有任何损坏。
- 禁止叠放托盘以避免包装箱受损。
- 所有托盘或其他包装应存放在平坦的表面上, 以避免倒塌。
- 所有产品必须存放在干燥、通风良好, 且有遮盖的环境中, 确保产品不受环境条件(雨水、雪或湿度等)的影响, 以防止倒塌和潮气进入。

JA 保管条件:

- 設置前には、バッグ、箱、保護フィルムやパレットを含む製品すべてを当初のパッケージ内で保管して、損傷のないようにする必要があります。
- 箱の損傷を避けるため、パレットの積み上げは認められません。
- パレットすべて、またはその他のパッケージは、倒壊を避けるべく平らな表面に保管する必要があります。
- 製品は全て乾燥し換気され屋根に覆われた環境で保管し、環境条件(雨、雪または湿度など)から製品が保護され、倒壊や湿気の侵入を確実に防止できるようにしてください。



XS: 258841



S: 247433



L: 250381



XL: 248217

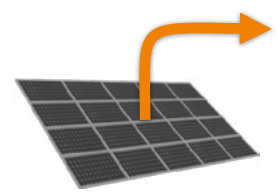
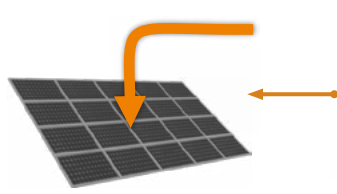

- EN** FOR USE CONDITIONS, PERFORMANCES AND DIMENSIONS: PLEASE REFER TO THE DOCUMENT: SPECIFICATIONS (Z-DRAWING)
- ES** PARA CONDICIONES DE USO, PRESTACIONES Y DIMENSIONES: CONSULTE EL DOCUMENTO: ESPECIFICACIONES (Z-DRAWING)
- FR** POUR LES CONDITIONS D'UTILISATION, LES CARACTÉRISTIQUES ET LES DIMENSIONS : VEUILLEZ CONSULTER LE DOCUMENT : SPÉCIFICATIONS (Z-DRAWING)
- PT** PARA AS CONDIÇÕES DE USO, PERFORMANCES E DIMENSÕES: CONSULTE O DOCUMENTO: ESPECIFICAÇÕES (Z-DRAWING)
- TR** KULLANIM ŞARTLARI, PERFORMANSLARI VE ÖLÇÜLERİ İÇİN: LÜTFEN BELGEYE BAŞVURUN: ÖZELLİKLER (Z-DRAWING)
- ZH** 有关使用条件、性能和尺寸：请参阅文档：规格说明（Z 轴图纸）
- JA** 使用条件、性能および寸法に関して：文書を参照してください：仕様（Z図）

1

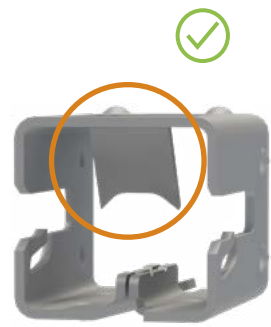
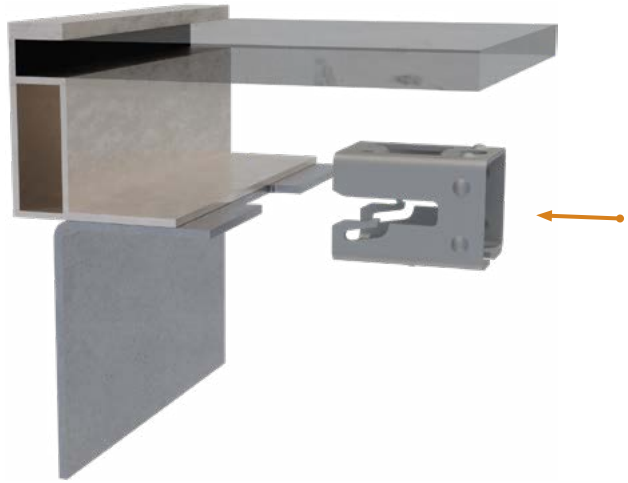
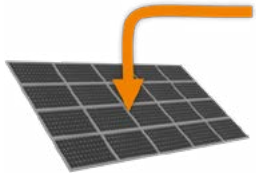

2

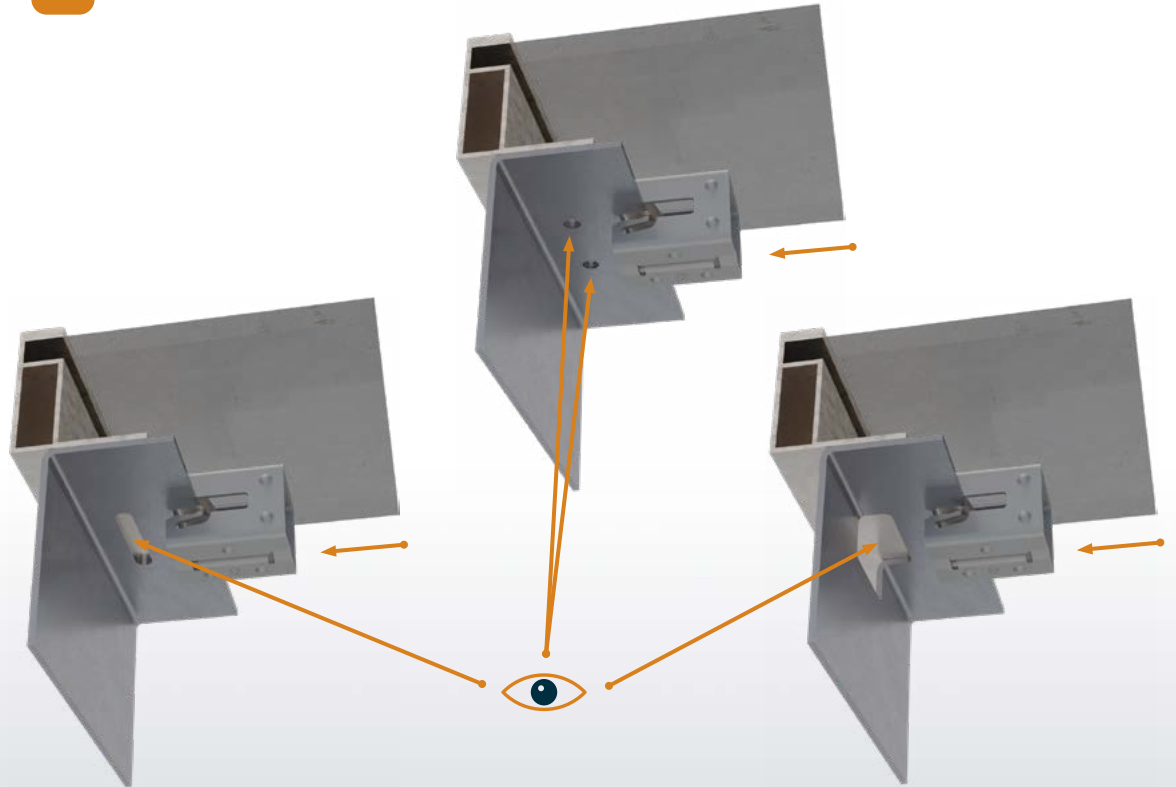

≥ x4 PowAR® Cinch Locked



3

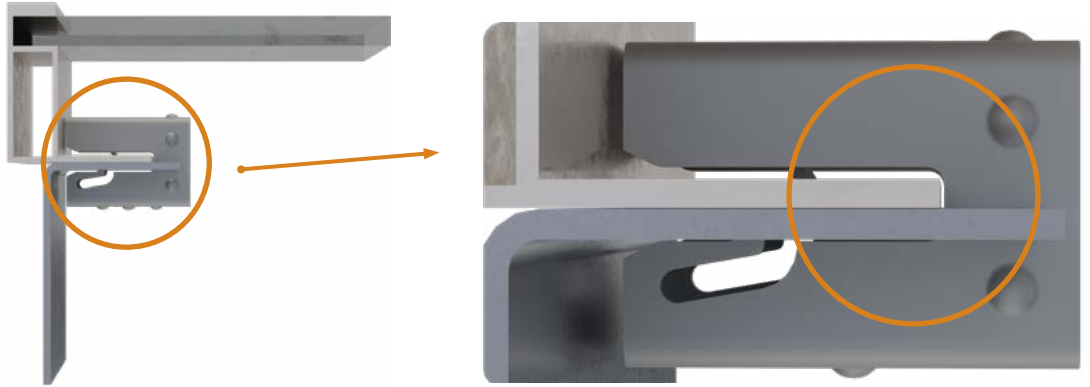
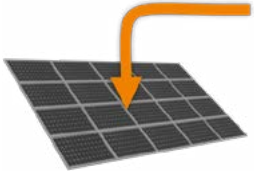

4

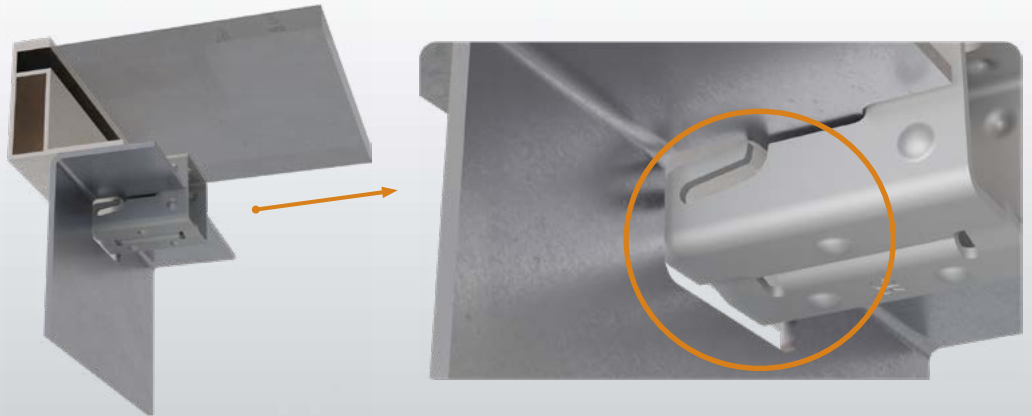
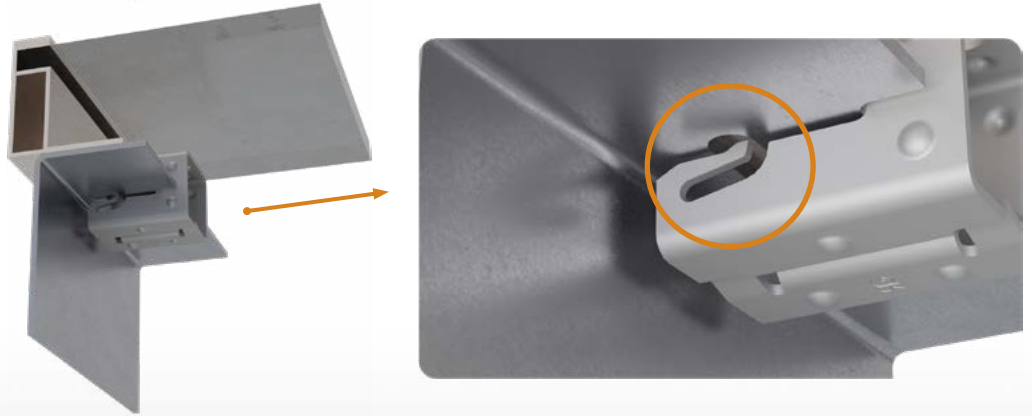
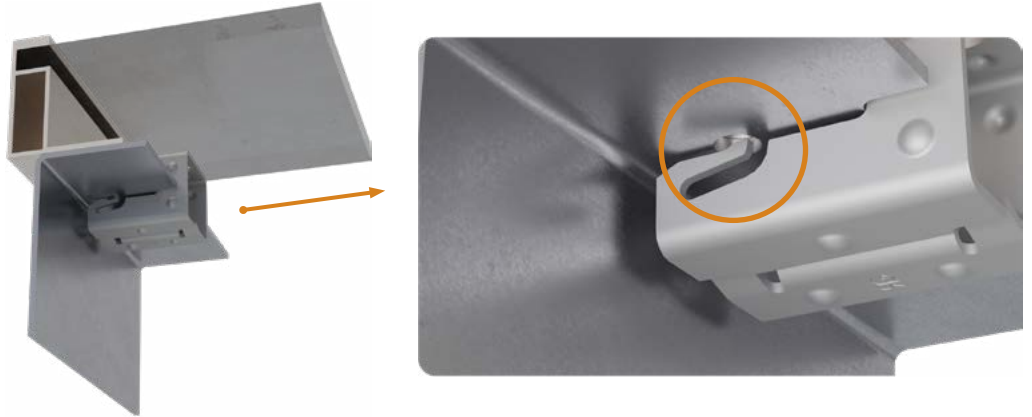

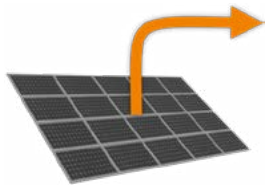

1

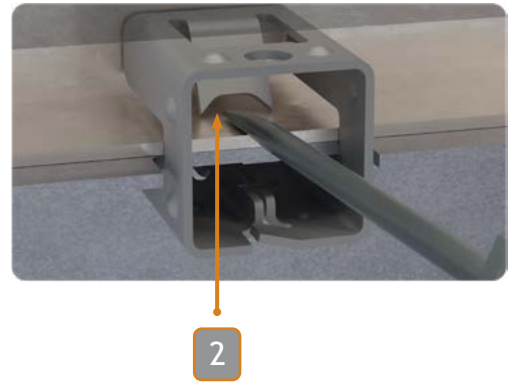
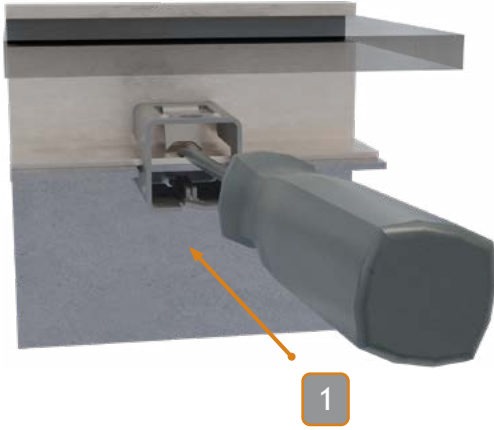

2

